

4	3	2	1				
CATEGORY	DESCRIPTION	P/N #	RFV	FCN NO	DFSCRIPTION	RFVISFD	DATF
CONNECTOR	RJ45 8P8C 防水连接器焊线式						

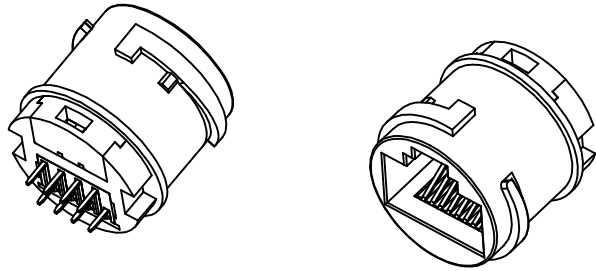

**SPECIFICATION**

- VOLTAGE RATING: 150 VAC RMS.
- CURRENT RATING: 1.5 AMP
- CONTACT RESISTANCE: 40 mΩ MAX
- INSULATION RESISTANCE: 500MΩ MIN.
- WITHSTAND VOLTAGE: AC1000V 60S MIN.
- OPERATING TEMPERATURE: -40°C~+80°C

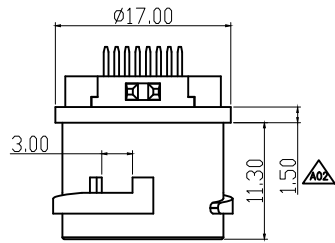
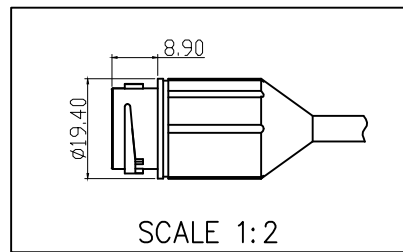
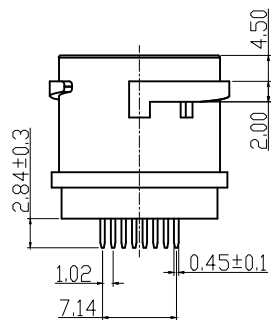
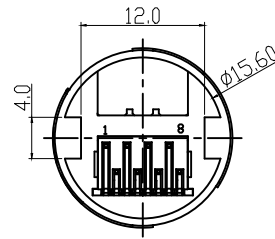
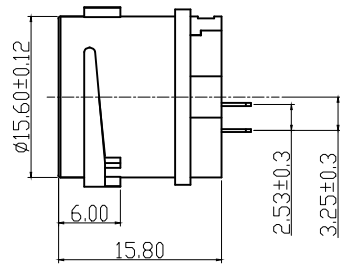
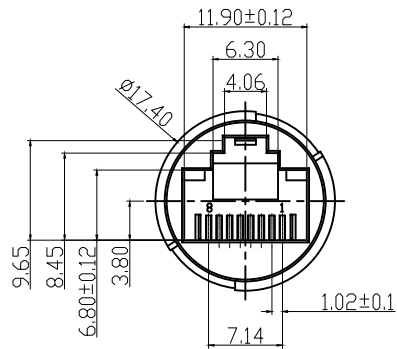

SCALE 1:2  
外模成型参考尺寸

**Coorle Technology**

d	COVER	1	PBT (4830) UL94V-0	BLACK	Changchun	UNLESS OTHERWISE SPECIFIED TOLERANCES	SCALE:1/1	UNIT: mm	DWG.NO:
c	TERMINAL	8	PHOSPHOR BRONZE (C5191R-H) T=0.3mm	Au/TIN PALTING	Liaoningjinke		SIZE: A3	PAGE:1 OF 1	
b	INSERT	1	PA9T (GN2330) UL94V-0	BLACK	Kuraray	DECIMALS:	APPROVED BY	CHECKED BY	PREPARED BY
a	HOUSING	1	PBT (4830) UL94V-0	BLACK	Changchun	X :±0.5			
						X.X :±0.3			
						X.XX :±0.2			
NO.	PART NAME	Q'TY	MATERIAL	PLATING & COLOR	ORIGINAL COUNTRY		CUSTOMER COPY		